

Blindspace TrackTrim® R508

for recessed curved tracks with 20.0" [508mm] radius

TRACK CURVE SECTION R508

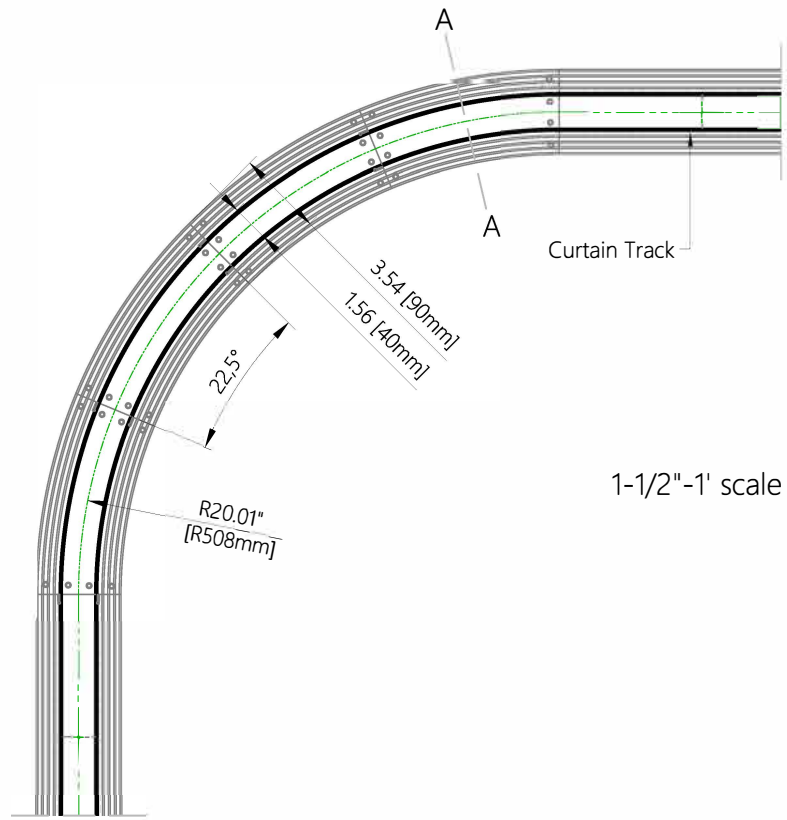

1-1/2"-1' scale

SECTION A-A

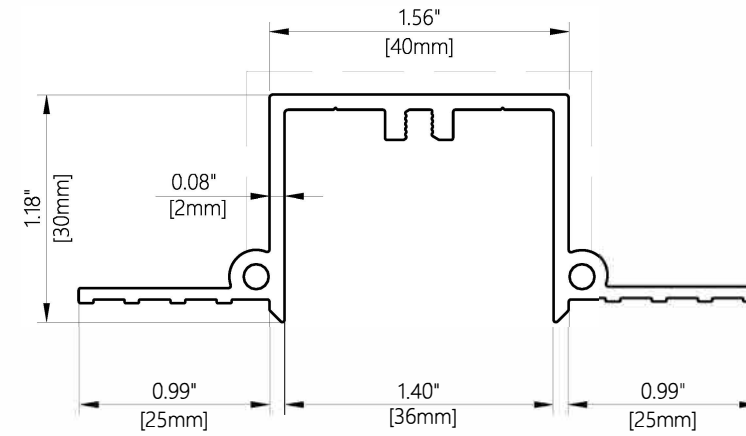

1'-1' full scale

EXAMPLE CURVES

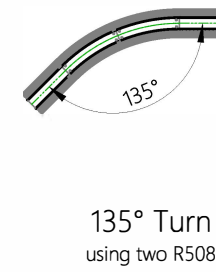

PRODUCT REFERENCE

TrackTrim®
R250

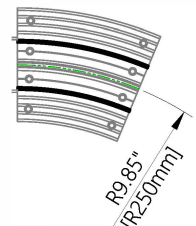

TrackTrim®
R330

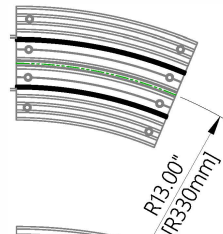

TrackTrim®
R480

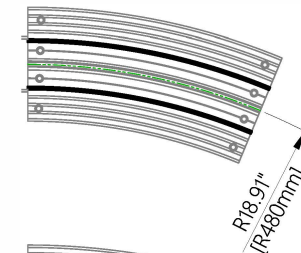

TrackTrim®
R290

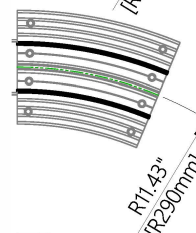

TrackTrim®
R365

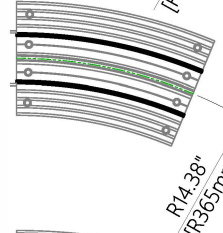

TrackTrim®
R508

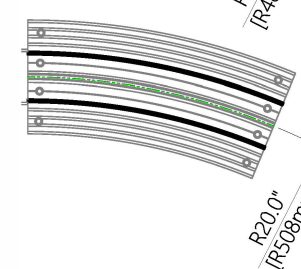

TrackTrim®
R300

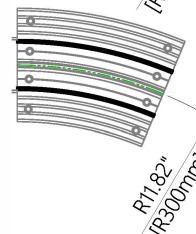

TrackTrim®
R440

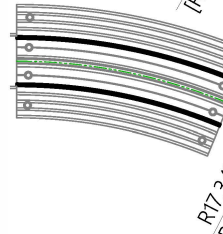

CAUTION: For further details and all possible configurations visit blindspace.com. For curtain stack sizes, please consult with curtain track specifications.

Product	Blindspace TrackTrim Curved Track Section
Description	Recessed profiles to house curtain tracks.
Curtain size	Please see size chart and supplier details for curtain such as max. length and weight.
Finishes	White to be plastered in and decorated at site to match ceiling.
Material	PETG Polyethylene Terephthalate
Installation	<p>Please refer to Sample Installation Drawings available both in PDF and DWG at blindspace.com</p> <p>Tracks to be fixed with countersunk screws using holes through back and both flanges into appropriate backing. Scrim tape to be used on flanges. Finished plaster level to be flush with chamfered edge. Allow 0.12" [3mm] recess space for ease of installation, shown in dash line around tracks</p>
Print date	2024/01/15
Page size	ISO A3 420x297
Print file	blindspace tracktrim curved tracks r508 [inch].dwg