

# Blindspace TrackTrim® R300

for recessed curved tracks with 11.82" [300mm] radius

## TRACK CURVE SECTION R300

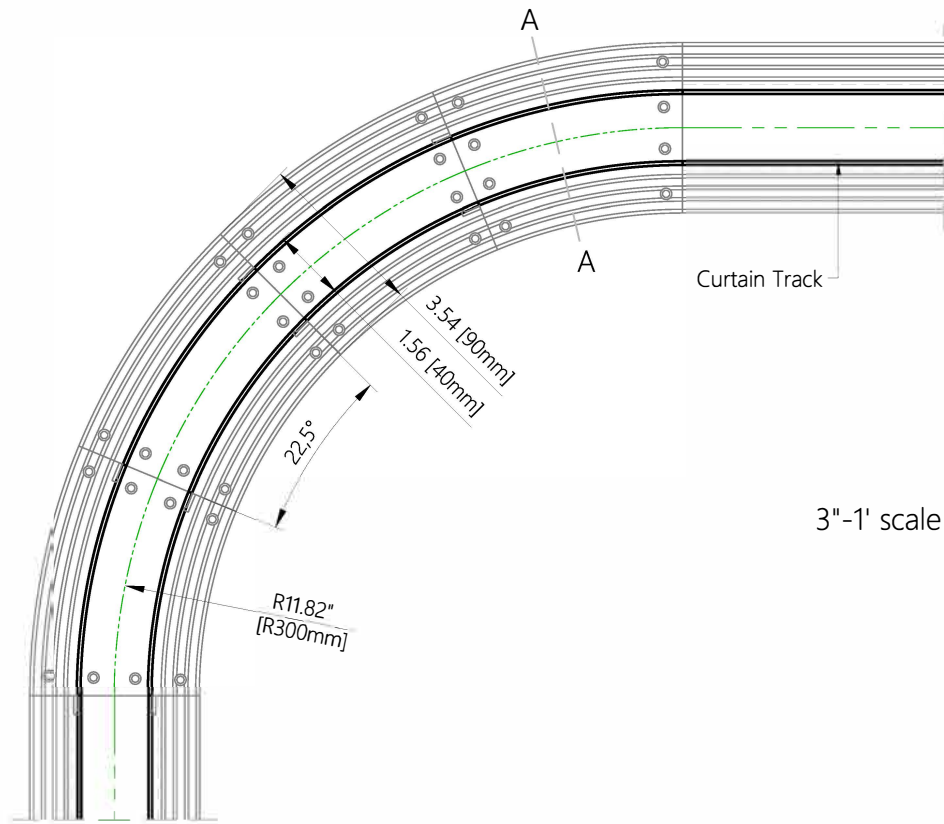

3"-1' scale

## SECTION A-A

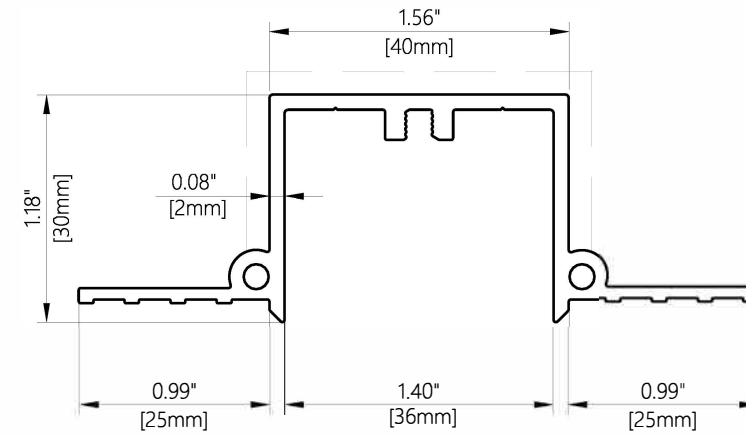

1'-1' full scale

## EXAMPLE CURVES

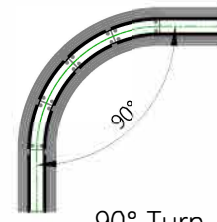

90° Turn  
using four R300

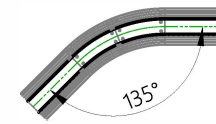

135° Turn  
using two R300

## PRODUCT REFERENCE

TrackTrim®  
**R250**

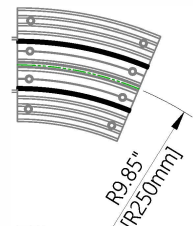

TrackTrim®  
**R330**

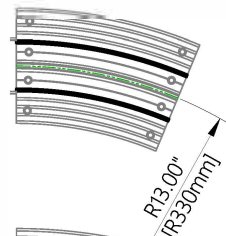

TrackTrim®  
**R480**

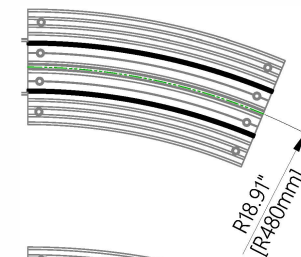

TrackTrim®  
**R290**

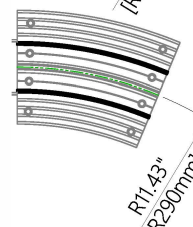

TrackTrim®  
**R365**

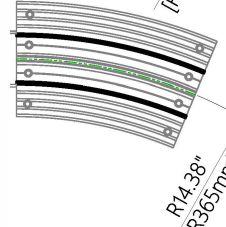

TrackTrim®  
**R508**

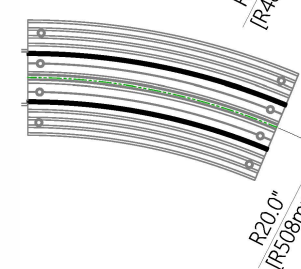

TrackTrim®  
**R300**

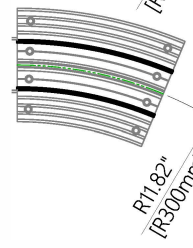

TrackTrim®  
**R440**

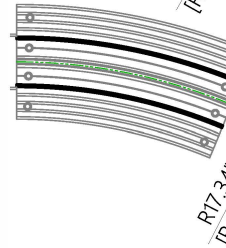

CAUTION: For further details and all possible configurations visit [blindspace.com](http://blindspace.com). For curtain stack sizes, please consult with curtain track specifications.

Product	Blindspace TrackTrim Curved Track Section
Description	Recessed profiles to house curtain tracks.
Curtain size	Please see size chart and supplier details for curtain such as max. length and weight.
Finishes	White to be plastered in and decorated at site to match ceiling.
Material	PETG Polyethylene Terephthalate
Installation	<p>Please refer to Sample Installation Drawings available both in PDF and DWG at <a href="http://blindspace.com">blindspace.com</a></p> <p>Tracks to be fixed with countersunk screws using holes through back and both flanges into appropriate backing. Scrim tape to be used on flanges. Finished plaster level to be flush with chamfered edge. Allow 0.12" [3mm] recess space for ease of installation, shown in dash line around tracks</p>
Print date	2024/01/15
Page size	ISO A3 420x297
Print file	blindspace tracktrim curved tracks r300 [inch].dwg